

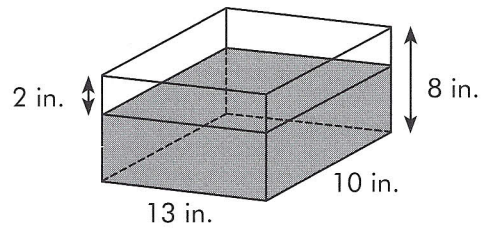

5. The volume of water in the tank shown below is \_\_\_\_\_.

- (1) 260 in.<sup>3</sup>
- (2) 480 in.<sup>3</sup>
- (3) 780 in.<sup>3</sup>
- (4) 1,040 in.<sup>3</sup>



( )

6. ABC and ADE are triangles.  $\angle BAC = 20^\circ$  and  $\angle BCE = 125^\circ$ . Find  $\angle CBD$ .

- (1)  $55^\circ$
- (2)  $75^\circ$
- (3)  $105^\circ$
- (4)  $125^\circ$

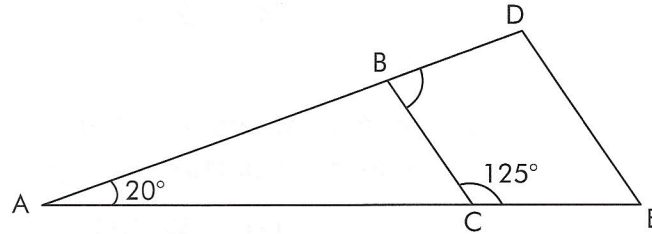

( )

7. Convert 8.052 L to liters and milliliters.

- (1) 8 L 52 mL
- (2) 8 L 502 mL
- (3) 8 L 520 mL
- (4) 80 L 52 mL

( )

8. AB and CD are straight lines. Find the sum of  $\angle a$  and  $\angle c$ . The figure below is not drawn to scale.

- (1)  $76^\circ$
- (2)  $93^\circ$
- (3)  $104^\circ$
- (4)  $145^\circ$

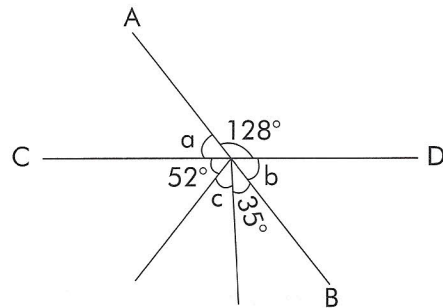

( )

9. Simon bought a computer for \$561.75, including 7% tax. How much was the computer without tax?

- (1) \$500
- (2) \$525
- (3) \$555
- (4) \$561

( )

10. The figure below is not drawn to scale. Find  $\angle a$ .

- (1)  $27^\circ$
- (2)  $50^\circ$
- (3)  $57^\circ$
- (4)  $67^\circ$

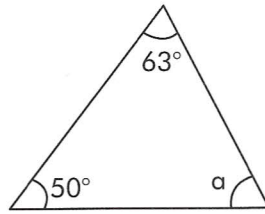

( )

11. The total height of 3 girls and 2 boys is 535 cm. The total height of the 3 girls is 327 cm. What is the difference of the average height between each girl and each boy?

- (1) 2 cm
- (2) 3 cm
- (3) 4 cm
- (4) 5 cm

( )

12. Uncle Roy bought 72 kg of seafood for his restaurant. 45% of the seafood were crabs, 15% of the seafood were scallops, and the rest were shrimp. How many grams of shrimp were there?

- (1) 10,800 g
- (2) 28,800 g
- (3) 32,400 g
- (4) 43,200 g

( )

13.  $0.978 \times \square = 97.8$ . The missing number in the box is \_\_\_\_\_.

- (1) 10
- (2) 100
- (3) 1,000
- (4) 10,000

( )

14. The figure below, not drawn to scale, is made of 2 triangles. Find  $\angle ABC$ .

- (1)  $24^\circ$
- (2)  $66^\circ$
- (3)  $114^\circ$
- (4)  $156^\circ$

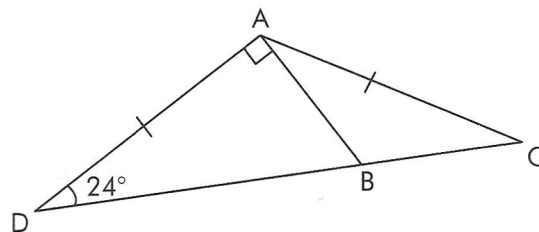

( )

15. Which of the following figures is not a trapezoid?

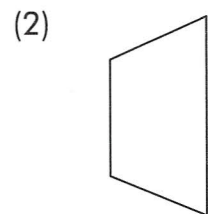
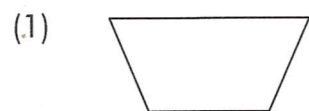

( )

**Write your answers on the lines.**

16.  $104 \div 1,000 =$  \_\_\_\_\_

17. Kaitlyn bought 13 yd. of fabric to make some dresses. A yard of fabric costs \$2.99. How much did she spend?

18. Write 0.02 as a percentage.

19. The average mass of Luis, Ian, and Lucy is 42 kg.  
The average mass of Luis, Lucy, and Will is 45 kg.  
If Luis's mass is 36 kg and Lucy's mass is 40 kg, find the total mass of Ian and Will.

20. Aliyah spends 54% of her birthday money. If she receives \$60 for her birthday, how much does she spend?

21. Mrs. Spencer makes 1.8 liters of iced tea every day. If she makes the same amount of iced tea for 2 weeks, how much tea does she make altogether? Write your answer in milliliters.

22. The figure below is not drawn to scale. Find  $\angle OQP$ . Identify what type of triangle OPQ is.

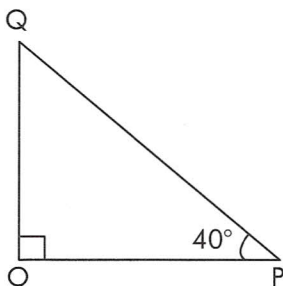

23. RST is a triangle, not drawn to scale.  $\angle TSU = 82^\circ$  and  $\angle SUR = 144^\circ$ .  
Find  $\angle STU$ .

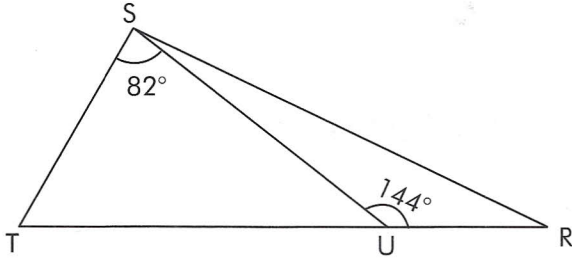

\_\_\_\_\_

24. The capacity of a bathtub is 40 gal. When it is only 30% filled with water, how much more water is needed to fill the bathtub completely?

\_\_\_\_\_

25. Complete the drawing of the cuboid below.

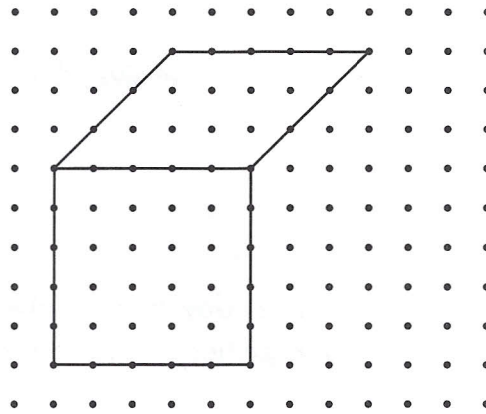

26. Kimiko earns \$1,440 a month by teaching part-time at a college. If she teaches 20 hours a month, what is her average hourly pay?

\_\_\_\_\_

27. Write 52% as a fraction in its simplest form.

\_\_\_\_\_

28. The total age of 3 children is 19 years 3 months. What is their average age? Write your answer in years and months.

\_\_\_\_\_

29. Deshawn invests \$12,500 in a fund. The interest rate is 8.5% per year. How much will he have in the fund after a year?

\_\_\_\_\_

30. ABCD is a parallelogram, not drawn to scale.  $\angle BAD = 27^\circ$  and  $\angle ADB = 65^\circ$ . Find  $\angle DBC$ .

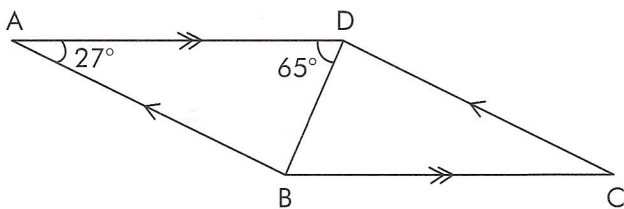

\_\_\_\_\_

 Write your answers on the lines. You may use a calculator.

31. There are 6,055 students in a school. 3,633 of them are girls. What percentage of the students are boys?

\_\_\_\_\_

32. A blue pen costs \$1.95. Find the total cost of 20 dozen identical blue pens.

\_\_\_\_\_

33. Find the volume of a cube whose edge is 36 cm.

\_\_\_\_\_

34. Divide 3,120.75 by 15.

\_\_\_\_\_

35. Find the value of  $32.05 \times 13$ .

\_\_\_\_\_



Show your work, and write your answers in the space below. You may use a calculator.

36. There are 900 students in a school. 720 of the students take Spanish. 0.75 of the remaining students take French and the rest take Latin. How many students take Latin?

37. The figure below, not drawn to scale, is made of a parallelogram and a triangle.  $\angle GFJ = 68^\circ$  and  $\angle FJG = 48^\circ$ . Find  $\angle EFG$ .

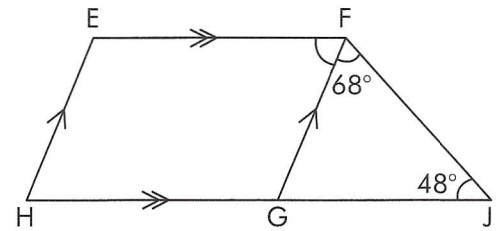

38. The figure below, not drawn to scale, is made of an isosceles triangle SQR and an equilateral triangle PQR.  $\angle RSQ = 134^\circ$ . Find  $\angle SQP$ .

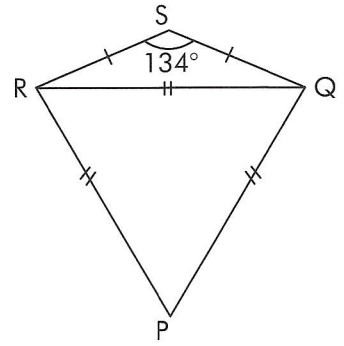

39. During weekdays, a museum has an average of 790 visitors per day. During weekends, the total number of visitors is 2,910. What is the average number of visitors per day during the course of an entire week?



40. Anna bought a small boat that cost \$2,999 and a trailer for \$699. She paid 7% in tax for the 2 items.
- (a) How much money did she pay in tax?
  - (b) How much did she pay altogether?

41. Draw a trapezoid ABCD in which  $AD \parallel BC$ ,  $AB = 2$  cm,  $BC = 7$  cm,  $\angle ABC = 44^\circ$ , and  $\angle BCD = 38^\circ$ .

42. Eli spends 20% of his salary on food and spends another 32% on housing. If he has spent \$585 on food and housing, how much is Eli's salary?
43. The owner of a store had a sack of flour that weighed 60 kg. He sold 0.45 of the flour to Mr. Romero and  $\frac{33}{100}$  of the flour to Mrs. Drew. After selling flour to both of them, he packed the remaining flour into bags weighing 120 g. How many 120-g bags of flour did he pack?

44. Henry earns \$12.40 per hour if he works at least 8 hours a day. He earns 1.5 times his normal hourly rate for every additional hour he works in a day. How much does Henry earn if he works 10 hours each day for 5 days?

45. A tank measuring 35 in. by 19 in. by 31 in. is filled with some water. Find the volume of water needed to fill the tank completely.

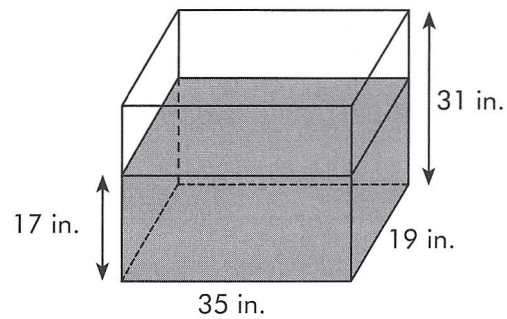

46. It took Meghan 12 minutes to draw 4 patterns on some fabric. How many patterns could she have drawn in 9 hours and 36 minutes?
47. A machine can pack 200 bars of soap in 5 minutes. How many bars of soap can the machine pack in 1.5 hours?

48. Jimmy has a tank 80 cm long, 60 cm wide, and 120 cm high. Water flows into the tank for  $1\frac{1}{2}$  hours at a rate of 1.6 liters per minute. (1 L = 1,000 cm<sup>3</sup>)
- (a) How much water will be in the tank after  $1\frac{1}{2}$  hours? Write your answer in cubic centimeters.
- (b) How many hours will it take for the tank to be completely filled?